



Fusign

 伏赛电子有限公司
 Fusign Electronics Co., Ltd

型号

EE-0804

REV	REVISIONS REC	DATE

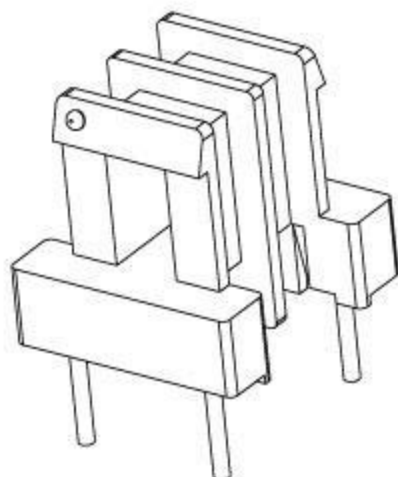
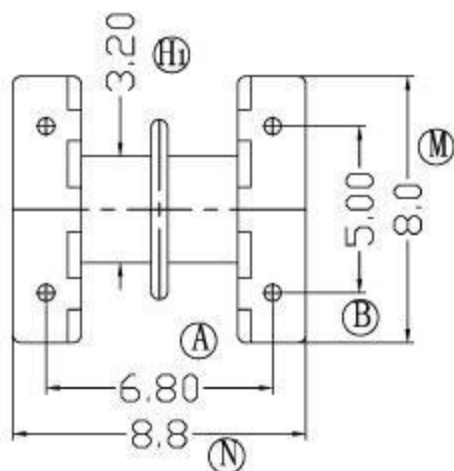
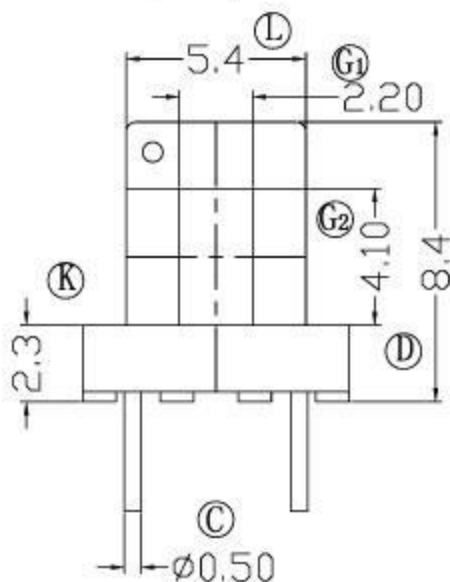
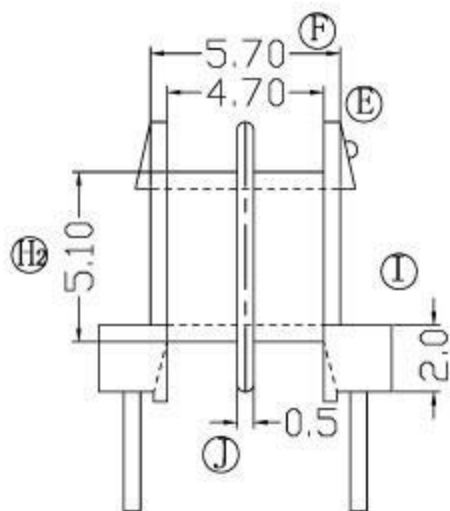

DRAWN BY	JING LI PENG	TOLERANCE	MODEL NAME:	EE-8.3(2+2P)-2S	
CHECKER BY	LING RONG WANG		X.X ± 0.3	BOBBIN MATERIAL:	PHENOLIC
DATE	01-01-2008	X.XX ± 0.2	SCALE:	4:1	SCALE: UL 94V-0
		壁厚: ± 0.15			SCALE: M/M
		PINPITCH ± 0.2			