



Fusign

伏赛电子有限公司
Fusign Electronics Co., Ltd

型号

EE-4005

REV	REVISIONS REC	DATE

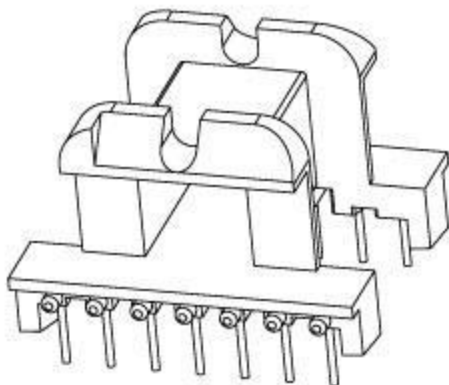
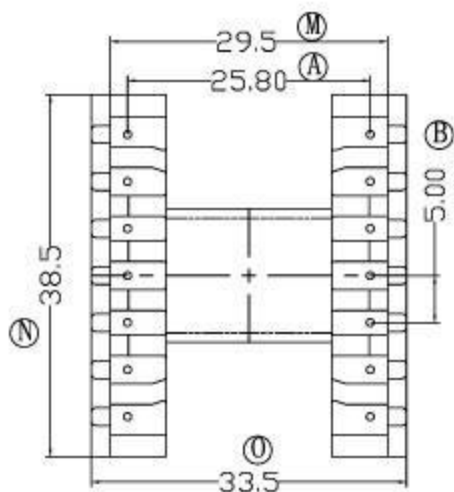
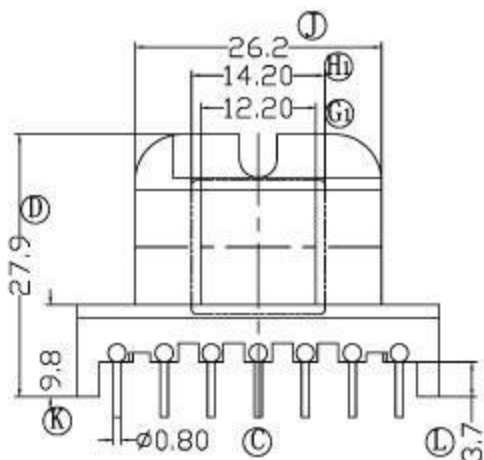
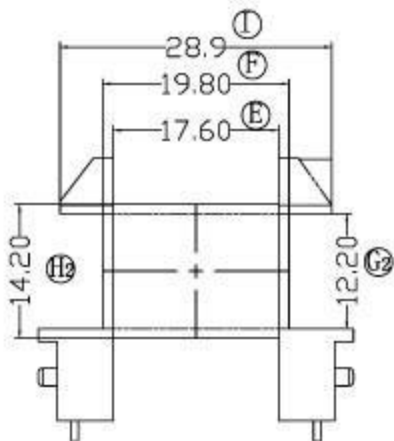

DRAWN BY	JING LI PENG	TOLERANCE	MODEL NAME:	EE40-14P-1S
CHECKER BY	LING RONG WANG	X. X ± 0.3	BOBBIN MATERIAL:	PHENOLIC
DATE	01-01-2008	X. XX ± 0.2	SCALE:	1:1
		壁厚: ± 0.15	SCALE:	UL 94V-0
		PINPITCH ± 0.2	SCALE:	M/M