



伏赛电子有限公司
Fusign Electronics Co., Ltd

型号

EF-2001

REV	REVISIONS REC	DATE

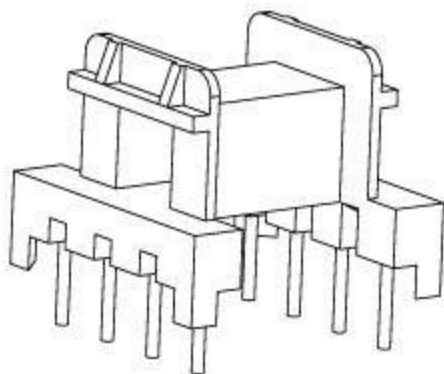
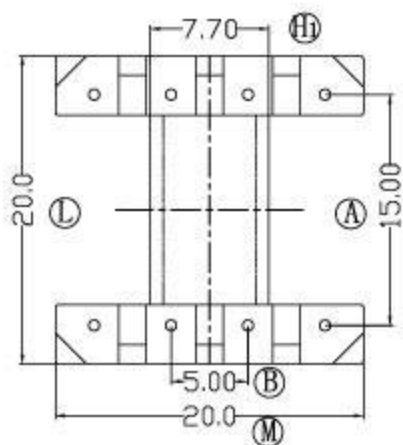
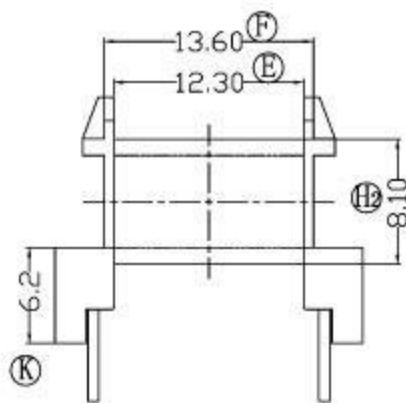
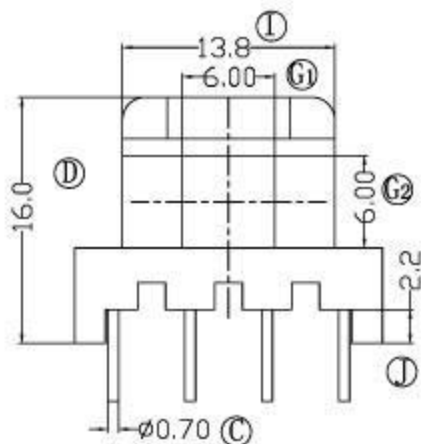

DRAWNBY	JING LI PENG
CHECKER BY	LING RONG WANG
DATE	01-01-2008

TOLERANCE	
X. X	± 0.3
X. XX	± 0.2
壁厚:	± 0.15
PINPITCH	± 0.2

MODEL NAME:	EF-20 (4+4P)	
BOBBIN MATERIAL:	PHENOLIC	
SCALE:	4:1	SCALE: UL 94V-0
		SCALE: M/M