



伏赛电子有限公司
Fusign Electronics Co., Ltd

型号

EF-2508-2

REV	REVISIONS	REC	DATE

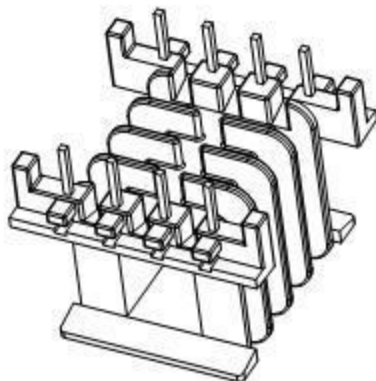
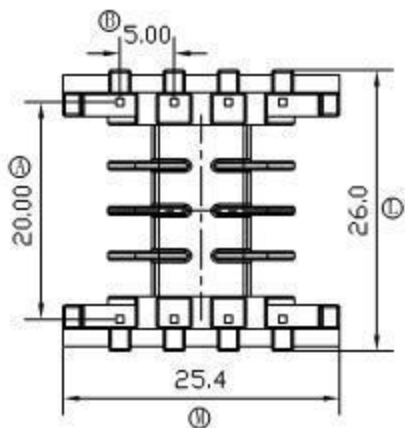
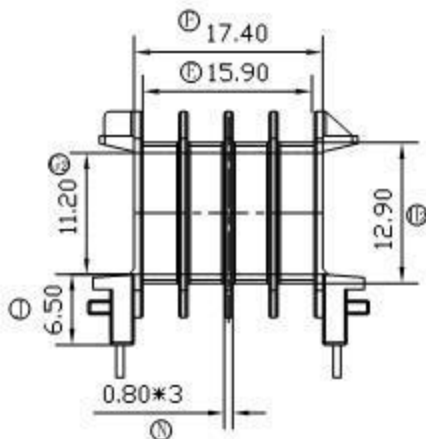
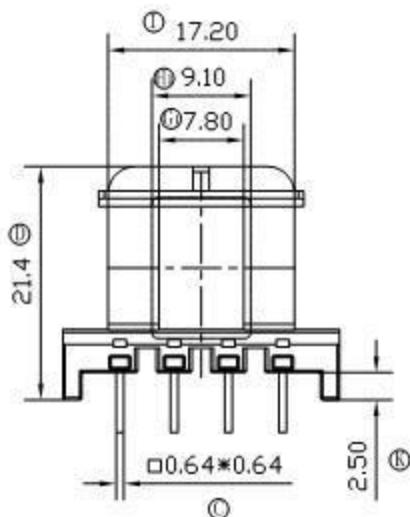

DRAWNBY	JING LI PENG	TOLERANCE	MODEL NAME:	EF25-8P-4S
CHECKER BY	LING RONG WANG	X, X ± 0.3	BOBBIN MATERIAL:	PET本色/NYLONG红色
DATE	01-01-2008	X, XX ± 0.2	SCALE:	2:1
		壁厚: ± 0.15	SCALE:	UL 94V-0
		PINPITCH ± 0.2	SCALE:	M/M

