



Fusign

伏赛电子有限公司  
Fusign Electronics Co., Ltd

型号

EI-1604

REV	REVISIONS REC	DATE

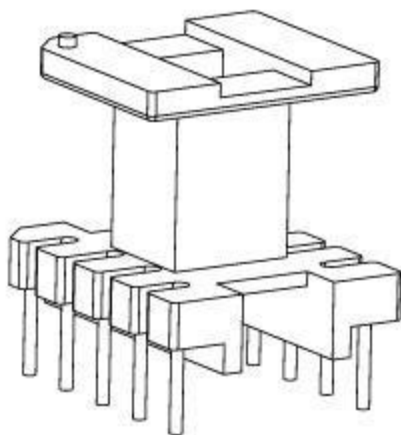
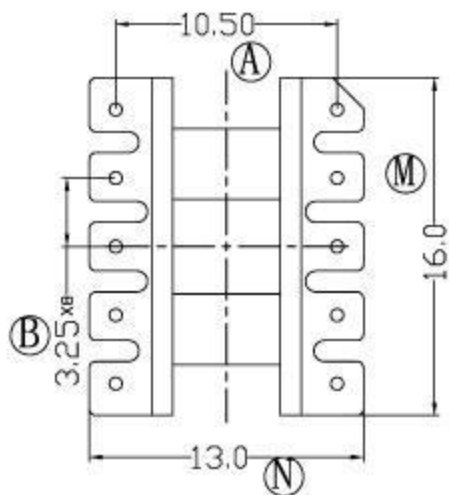
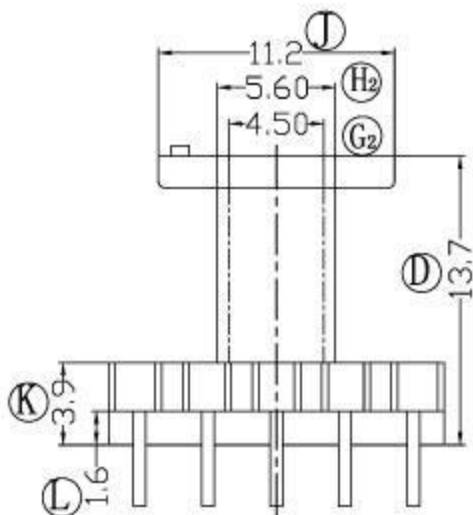
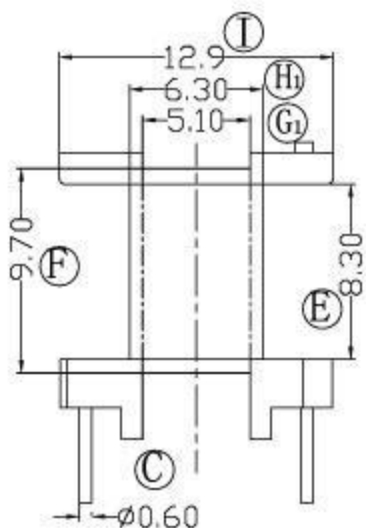

DRAWN BY	JING LI PENG
CHECKER BY	LING RONG WANG
DATE	01-01-2008

TOLERANCE	
X. X	± 0.3
X. XX	± 0.2
壁厚:	± 0.15
PIN PITCH	± 0.2

MODEL NAME:	EI-16 (5+5P)	
BOBBIN MATERIAL:	PHENOLIC	
SCALE:	2:1	SCALE: UL 94V-0
		SCALE: M/M