



Fusign

 伏赛电子有限公司  
 Fusign Electronics Co., Ltd

型号

EI-3301

REV	REVISIONS REC	DATE

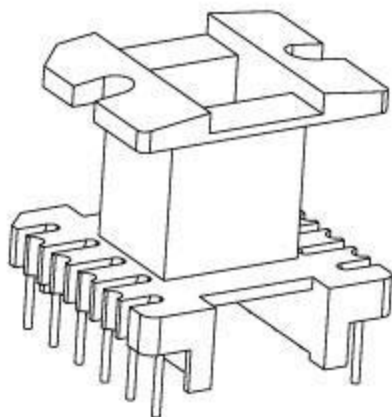
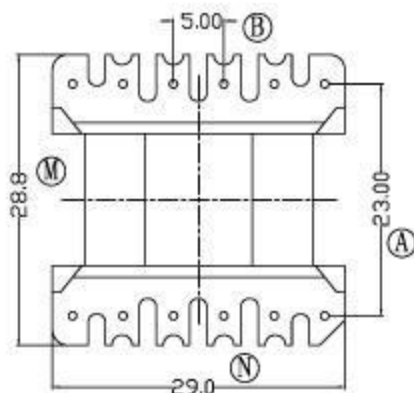
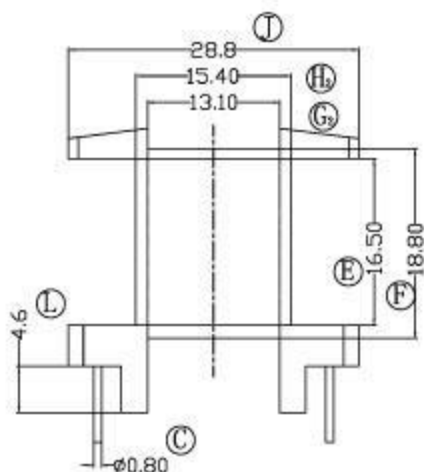
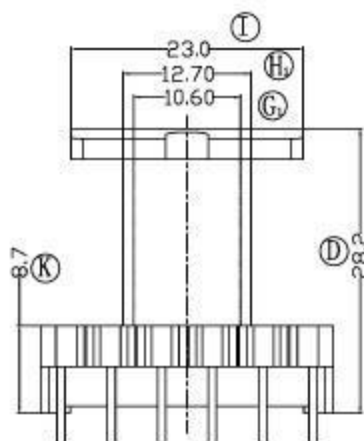

DRAWNBY

JING LI PENG

TOLERANCE

MODEL NAME:

EI-33 (6+6P)

CHECKER BY

LING RONG WANG

X. X	± 0.3
X. XX	± 0.2
壁厚:	± 0.15
PINPITCH	± 0.2

BOBBIN MATERIAL:

PHENOLIC

DATE

01-01-2008

SCALE:

2:1

SCALE: UL 94V-0



SCALE:

M/M