



Fusign

 伏赛电子有限公司
 Fusign Electronics Co., Ltd

型号

UT-2401-1

REV	REVISIONS REC	DATE

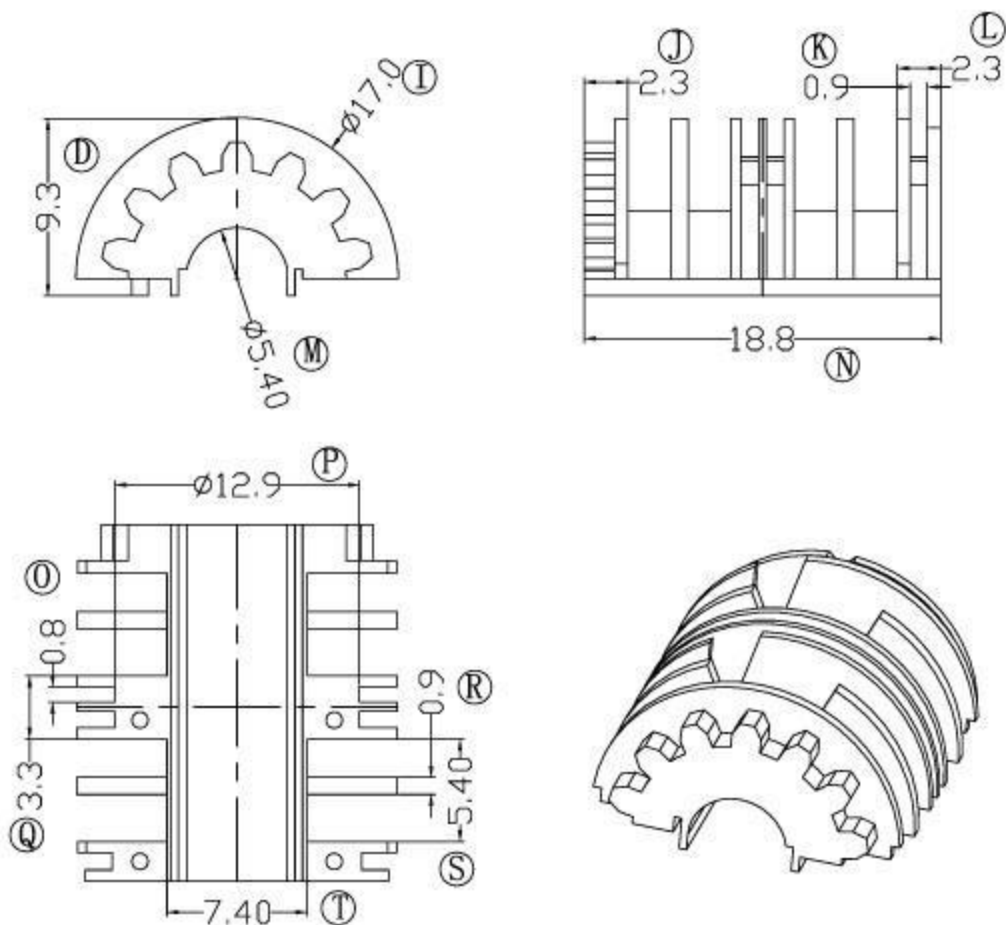

DRAWN BY

JING LI PENG

TOLERANCE

MODEL NAME:

ET-24-4S 线圈

CHECKER BY

LING RONG WANG

X.X	± 0.3
X.XX	± 0.2
壁厚:	± 0.15
PIN PITCH	± 0.2

BOBBIN MATERIAL:

PBT

DATE

01-01-2008

SCALE:

3:1

SCALE: UL 94V-0



SCALE:

M/M