

50/60HZ PCB MOUNT TRANSFORMERS – UI RANGE

14W 39 × 10.2–UI 3910 SERIES

FEATURES:

- 115 V–230 V supply voltage by serie/parallel connection
- Vacuum filling
- Two compartments bobbins
- Degree of protection IP 00

OPTIONS:

- Bulk packaging is standard
- Custom design available

COMMON APPLICATIONS:

- Medical equipments
- Industrial equipments
- Industrial controls
- Test equipment
- Industrial computers
- Avionics & telecom

ELECTRICAL CHARACTERISTICS

PRIMARY VOLTAGE: 115-230				
Part Number	Secondary voltage V	Secondary Current mA	No-load voltage V	Ambient Temperature °C
UI 391043	2 × 6	2 × 1187	2 × 7.5	T50B
UI 391044	2 × 9	2 × 778	2 × 10.9	T50B
UI 391045	2 × 12	2 × 583	2 × 15.0	T50B
UI 391046	2 × 15	2 × 467	2 × 18.7	T50B
UI 391047	2 × 18	2 × 389	2 × 22.4	T50B
UI 391048	2 × 24	2 × 292	2 × 30.2	T50B

PHYSICAL CHARACTERISTICS

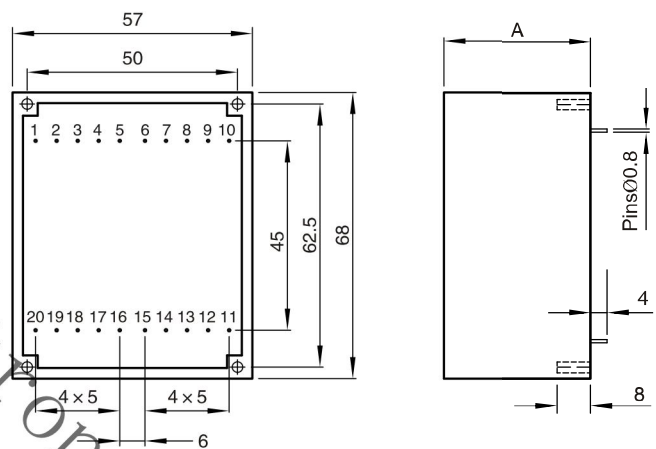

All dimensions in mm

TECHNICAL INFORMATION

- Resin class UL 94 VO
- Fuse protection in secondary winding (see diagram)
- Insulation voltage 4 KV
- 100% tested production
- Conform to EN 61558 Approval under process

CIRCUIT	RATING	DIMENSION:A	WEIGHT(g)
UI39 × 8	10VA	A=22mm	285
UI39 × 10.2	14VA	A=24mm	335
UI39 × 13.5	18VA	A=27mm	405
UI39 × 17	24VA	A=31mm	260
UI39 × 21	30VA	A=35mm	550

Possible primary connections

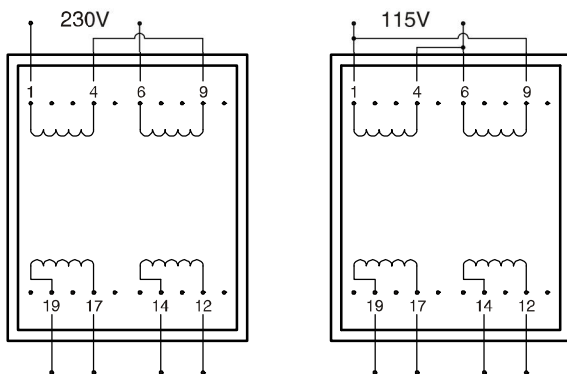

Possible secondary connections

