

Split Core Current Transformers

SCTK671 Series

SCTK671 series retro-fit (split-core) current transformer has been specially designed to facilitate their installation in new or already existing net works. They may be installed without opening any cable or bus-bar circuit. An internal precision resistor across the secondary winding of the CT provides a low safe voltage output. It can save time and the installation costs.

◆ Features

- Epoxy Potting, Double-screw fastening, safe, easy to install, portable
- Wide inner window, allowing clamping of big cables or bus-bars
- Wide range of sizes to accommodate all the existing installations

◆ Applications

- Current measurement, monitoring and protection for electrical wiring and equipment.
- Current and power measurement for electric motors, lighting, air compressor, heating and ventilation system, air-condition equipment and automation – control system.
- Current, power and energy monitoring device.
- Relay protection device.

◆ Circuit connection diagram

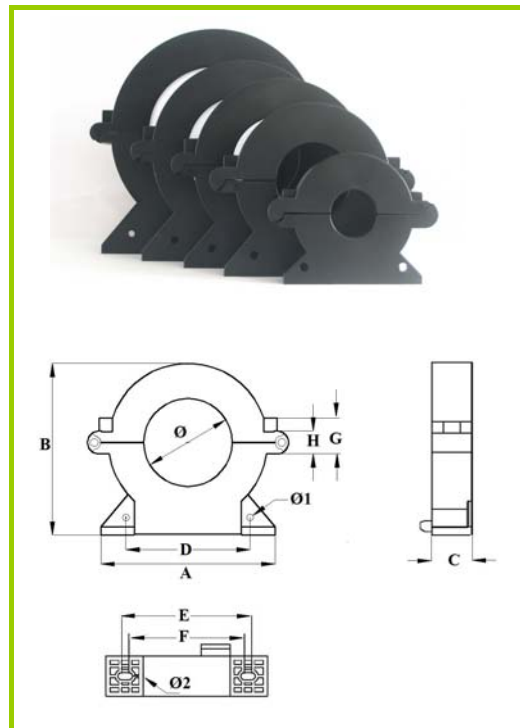
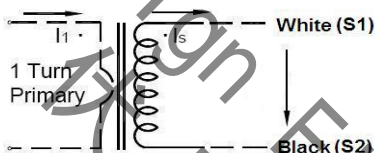

◆ Technique Index

Electrical Parameter	
Frequency	50-400Hz
Rated Input	5A-3000A
Measuring range	5%In-130%In
Rated Output	0-10V(AC) or 0-5A
Ratio	≤ ± 0.2%
Phase angle	≤ ±10min
Dielectric strength	2.5KV/1mA/1min
Insulation Resistance	DC500V/100MΩ min

Mechanical Parameter	
Case	PC /UL94-V0
Bobbin	PBT
Core	Silicon steel
Internal structure	Epoxy
Construction	Tie
Operating Temp	-25℃ ~ +75℃
Operating Humidity	≤85%
Output Connection	UL1015 22AWG Wire(twinsted wire) 2.5m

◆ Type Selection (Output: mA/V)

Mfg P/N	Rated Input (A)	Output (mA/V)	Accuracy	Dimensions(mm/inch)									
				Ø	A	B	C	D	E	F	G	Ø1	Ø2
SCTK671A-025	5-400A (5, 100, 400A)	0-200mA 0-10V	0.2, 0.5, 1.0	25 (1.0)	98 (3.9)	75 (2.9)	22 (0.9)	58 (2.3)	85 (3.3)	70 (2.8)	22 (0.9)	16 (0.6)	5 (0.2)
SCTK671B-045	50-1000A (50, 400, 1000A)	0-500mA 0-10V	0.2, 0.5, 1.0	45 (1.8)	109 (4.3)	107 (4.2)	26 (1.0)	67 (2.6)	95 (3.7)	80 (3.2)	23 (0.9)	16 (0.6)	5 (0.2)
SCTK671C-065	100-1500A (100, 1000, 1500A)	0-500mA 0-10V	0.2, 0.5, 1.0	65 (2.6)	129 (5.1)	127 (5)	26 (1.0)	92 (3.6)	115 (4.5)	99 (3.9)	26 (1.0)	16 (0.6)	5 (0.2)
SCTK671D-080	500-2000A (500, 1500, 2000A)	0-500mA 0-10V	0.2, 0.5, 1.0	80 (3.1)	145 (5.7)	143 (5.6)	28 (1.1)	97 (3.8)	130 (5.1)	109 (4.3)	27 (1.1)	17 (0.7)	5 (0.2)
SCTK671E-100	800-3000A (800, 2500, 3000A)	0-600mA 0-10V	0.2, 0.5, 1.0	100 (3.9)	175 (6.9)	175 (6.9)	30 (1.2)	127 (5)	155 (6.1)	125 (4.9)	27 (1.1)	17 (0.7)	5 (0.2)

SCTK671 Series

◆ Type Selection (Output: 1A)

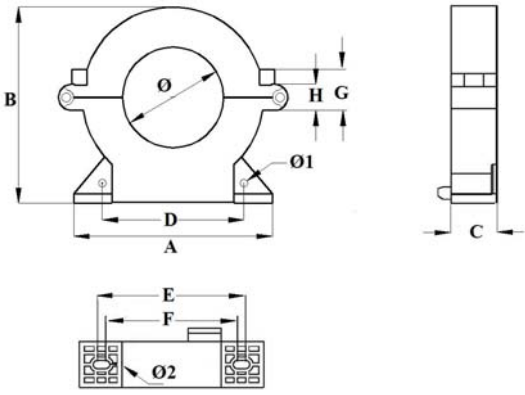
Mfg P/N	Input/Output (A)	Burden(VA)/Class				Product Description																																																																		
		0.2	0.5	1.0	3.0																																																																			
SCTK671A-025	50/1	---	---	1.5	2.5																																																																			
	100/1	---	1.5	2.5	3.75																																																																			
	150/1	---	1.5	2.5	3.75																																																																			
	200/1	---	2.5	3.75	5																																																																			
	250/1	---	1.5	3.75	5																																																																			
	300/1	---	2.5	5	10																																																																			
	400/1	1.5	2.5	5	10																																																																			
SCTK671B-045	50/1	---	---	1.5	2.5																																																																			
	100/1	---	1.5	2.5	3.75																																																																			
	250/1	---	2.5	3.75	5																																																																			
	500/1	---	1.5	3.75	5																																																																			
	600/1	1.5	3.75	7.5	10																																																																			
	800/1	1.5	3.75	7.5	10																																																																			
	1000/1	2.5	5	10	15																																																																			
SCTK671C-065	100/1	---	1.5	2.5	3.75	Dimensions(mm) <table border="1" data-bbox="853 1153 1476 1624"> <thead> <tr> <th>型号</th> <th>Ø</th> <th>A</th> <th>B</th> <th>C</th> <th>D</th> <th>E</th> <th>F</th> <th>G</th> <th>Ø1</th> <th>Ø2</th> </tr> </thead> <tbody> <tr> <td>671A</td> <td>25</td> <td>98</td> <td>75</td> <td>22</td> <td>58</td> <td>85</td> <td>70</td> <td>22</td> <td>16</td> <td>5</td> </tr> <tr> <td>671B</td> <td>45</td> <td>109</td> <td>107</td> <td>26</td> <td>67</td> <td>95</td> <td>80</td> <td>23</td> <td>16</td> <td>5</td> </tr> <tr> <td>671C</td> <td>65</td> <td>129</td> <td>127</td> <td>26</td> <td>92</td> <td>115</td> <td>99</td> <td>26</td> <td>16</td> <td>5</td> </tr> <tr> <td>671D</td> <td>80</td> <td>145</td> <td>143</td> <td>28</td> <td>97</td> <td>130</td> <td>109</td> <td>27</td> <td>17</td> <td>5</td> </tr> <tr> <td>671E</td> <td>100</td> <td>175</td> <td>175</td> <td>30</td> <td>127</td> <td>155</td> <td>125</td> <td>27</td> <td>17</td> <td>5</td> </tr> </tbody> </table>	型号	Ø	A	B	C	D	E	F	G	Ø1	Ø2	671A	25	98	75	22	58	85	70	22	16	5	671B	45	109	107	26	67	95	80	23	16	5	671C	65	129	127	26	92	115	99	26	16	5	671D	80	145	143	28	97	130	109	27	17	5	671E	100	175	175	30	127	155	125	27	17	5
	型号	Ø	A	B	C		D	E	F	G	Ø1	Ø2																																																												
	671A	25	98	75	22		58	85	70	22	16	5																																																												
	671B	45	109	107	26		67	95	80	23	16	5																																																												
	671C	65	129	127	26		92	115	99	26	16	5																																																												
	671D	80	145	143	28		97	130	109	27	17	5																																																												
	671E	100	175	175	30		127	155	125	27	17	5																																																												
250/1	---	2.5	3.75	5																																																																				
400/1	---	1.5	3.75	5																																																																				
600/1	1.5	3.75	7.5	10																																																																				
800/1	1.5	3.75	7.5	10																																																																				
1000/1	2.5	5	10	15																																																																				
1500/1	2.5	5	10	20																																																																				
SCTK671D-080	100/1	---	1.5	2.5	3.75																																																																			
	500/1	---	1.5	3.75	5																																																																			
	800/1	1.5	2.5	5	7.5																																																																			
	1000/1	2.5	5	10	15																																																																			
	1200/1	2.5	5	10	15																																																																			
	1500/1	2.5	5	10	20																																																																			
	2000/1	2.5	5	15	25																																																																			
SCTK671E-100	200/1	---	1.5	2.5	3.75																																																																			
	500/1	---	1.5	3.75	5																																																																			
	800/1	1.5	2.5	5	7.5																																																																			
	1000/1	2.5	5	10	15																																																																			
	1200/1	2.5	5	10	15																																																																			
	1500/1	2.5	5	10	20																																																																			
	2000/1	2.5	5	15	25																																																																			
	2500/1	5	10	15	30																																																																			
3000/1	5	10	20	45																																																																				

- NOTE:
- Rated Primary current :0-3000Aac
 - Rated Secondary current: 1A
 - Rated load: 2.5, 3.75, 5.0, 10,15, 20,30, 45VA
 - Accuracy: 0.2, 0.5, 1.0, 3.0 Class
 - Output Connection:2*2.5mm² Wire 1m or Terminal
 - Forbidden to open the second, otherwise, easy to produce high voltage

SCTK671 Series

◆ Type Selection (Output: 5A)

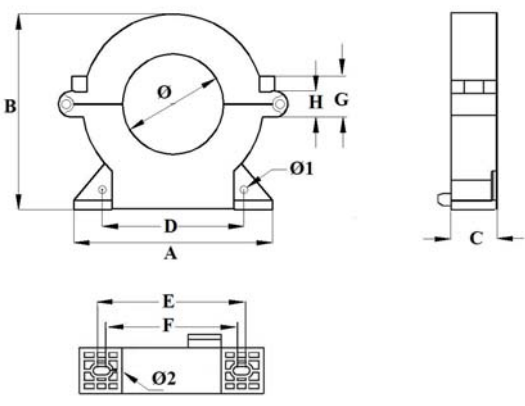
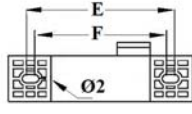
Mfg P/N	Input/Output (A)	Burden(VA)/Class				Product Description																																																																		
		0.2	0.5	1.0	3.0																																																																			
SCTK671A-025	50/5	---	---	---	1.5																																																																			
	100/5	---	---	---	2.5																																																																			
	150/5	---	---	1.5	2.5																																																																			
	200/5	---	---	1.5	3.75																																																																			
	250/5	---	---	2.5	3.75																																																																			
	300/5	---	1.5	2.5	3.75																																																																			
	400/5	---	1.5	2.5	3.75																																																																			
SCTK671B-045	250/5	---	---	2.5	3.75																																																																			
	300/5	---	1.5	2.5	3.75																																																																			
	400/5	---	1.5	2.5	3.75																																																																			
	500/5	---	1.5	5	10																																																																			
	600/5	---	2.5	5	10																																																																			
	800/5	---	3.75	7.5	10																																																																			
	1000/5	1.5	5	10	15																																																																			
SCTK671C-065	300/5	---	1.5	2.5	3.75																																																																			
	400/5	---	2.5	3.75	5																																																																			
	500/5	---	1.5	3.75	5																																																																			
	600/5	---	2.5	5	10																																																																			
	800/5	---	3.75	5	10																																																																			
	1000/5	1.5	5	10	15																																																																			
	1500/5	2.5	5	10	20																																																																			
SCTK671D-080	500/5	---	1.5	2.5	3.75	Dimensions(mm/inch) <table border="1"> <thead> <tr> <th>型号</th> <th>Ø</th> <th>A</th> <th>B</th> <th>C</th> <th>D</th> <th>E</th> <th>F</th> <th>G</th> <th>Ø1</th> <th>Ø2</th> </tr> </thead> <tbody> <tr> <td>671A</td> <td>25</td> <td>98</td> <td>75</td> <td>22</td> <td>58</td> <td>85</td> <td>70</td> <td>22</td> <td>16</td> <td>5</td> </tr> <tr> <td>671B</td> <td>45</td> <td>109</td> <td>107</td> <td>26</td> <td>67</td> <td>95</td> <td>80</td> <td>23</td> <td>16</td> <td>5</td> </tr> <tr> <td>671C</td> <td>65</td> <td>129</td> <td>127</td> <td>26</td> <td>92</td> <td>115</td> <td>99</td> <td>26</td> <td>16</td> <td>5</td> </tr> <tr> <td>671D</td> <td>80</td> <td>145</td> <td>143</td> <td>28</td> <td>97</td> <td>130</td> <td>109</td> <td>27</td> <td>17</td> <td>5</td> </tr> <tr> <td>671E</td> <td>100</td> <td>175</td> <td>175</td> <td>30</td> <td>127</td> <td>155</td> <td>125</td> <td>27</td> <td>17</td> <td>5</td> </tr> </tbody> </table>	型号	Ø	A	B	C	D	E	F	G	Ø1	Ø2	671A	25	98	75	22	58	85	70	22	16	5	671B	45	109	107	26	67	95	80	23	16	5	671C	65	129	127	26	92	115	99	26	16	5	671D	80	145	143	28	97	130	109	27	17	5	671E	100	175	175	30	127	155	125	27	17	5
	型号	Ø	A	B	C		D	E	F	G	Ø1	Ø2																																																												
	671A	25	98	75	22		58	85	70	22	16	5																																																												
	671B	45	109	107	26		67	95	80	23	16	5																																																												
	671C	65	129	127	26		92	115	99	26	16	5																																																												
	671D	80	145	143	28		97	130	109	27	17	5																																																												
	671E	100	175	175	30		127	155	125	27	17	5																																																												
600/5	---	2.5	5	10																																																																				
800/5	---	3.75	5	10																																																																				
1000/5	1.5	5	10	15																																																																				
1200/5	2.5	5	15	15																																																																				
1500/5	2.5	5	10	20																																																																				
2000/5	2.5	5	15	25																																																																				
SCTK671E-100	500/5	---	1.5	2.5	3.75	NOTE: <ul style="list-style-type: none"> ● Rated Primary current :0-3000Aac ● Rated Secondary current: 5A ● Rated load: 2.5, 3.75, 5.0, 10,15, 20,30, 45VA ● Accuracy: 0.2, 0.5, 1.0, 3.0 Class ● Output Connection:2*2.5mm² Wire 1m or Terminal ● Forbidden to open the second, otherwise, easy to produce high voltage 																																																																		
	600/5	---	1.5	3.75	5																																																																			
	800/5	---	2.5	5	7.5																																																																			
	1000/5	2.5	5	10	15																																																																			
	1200/5	2.5	5	10	15																																																																			
	1500/5	2.5	5	10	20																																																																			
	2000/5	2.5	5	15	25																																																																			
	2500/5	5	10	15	30																																																																			
3000/5	5	10	20	45																																																																				