

## Three Phase Current Transformers

# SCT28 Series

**SCT28 series** Three Phase current transformer is a combination of three transformers together to form one. It has been specially Designed for motor, An internal precision resistor across the secondary winding of the CT provides a low safe voltage output. It can save time and the installation costs.

### ◆ Features

- Epoxy Potting, Double-screw fastening, safe, easy to install, portable
- Wide inner window, allowing clamping of big cables or bus-bars
- Wide range of sizes to accommodate all the existing installations

### ◆ Applications

- Current measurement, monitoring and protection for electrical wiring and equipment.
- Current and power measurement for electric motors, lighting, air compressor, heating and ventilation system, air-condition equipment and automation – control system.
- Relay protection device.

### ◆ Circuit connection diagram

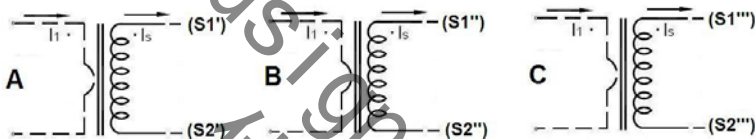

### ◆ Technique Index

Electrical Parameter	
Frequency	50-400Hz
Rated Input	5A-800A
Measuring range	5%In-130%In
Rated Output	0-10V(AC)
Ratio	≤ ± 0.1%
Phase angle	≤ ±5min
Dielectric strength	2.5KV/1mA/1min
Insulation Resistance	DC500V/100MΩ min

Mechanical Parameter	
Case	ABS /UL94-V0
Bobbin	PBT
Core	Silicon steel
Internal structure	Epoxy
Construction	Screw
Operating Temp	-25°C ~ +75°C
Operating Humidity	≤85%
Output Connection	4-cell or 6-cell shielded wire

### ◆ Type Selection

Mfg P/N	Input(A)	Output(A)	Accuracy	Max overload multiples	Hole size (mm)	Mounting means
SCT2851	0-20A	0-10V	0.1, 0.2	10/3s	3* Ø 5.0	Screw
SCT2861	0-50A	0-10V	0.1, 0.2	10/3s	3* Ø 7.0	Screw
SCT2871	0-100A	0-10V	0.1, 0.2	10/3s	3* Ø 10.0	Screw
SCT2881A	0-200A	0-10V	0.1, 0.2	10/3s	3* Ø 20.0	Screw
SCT2881B	0-250A	0-10V	0.1, 0.2	10/3s	3* Ø 20.0	Screw
SCT2881D	0-200A	0-10V	0.1, 0.2	10/3s	3* Ø 19.0	Screw
SCT2881E	0-200A	0-10V	0.1, 0.2	10/3s	3* Ø 7.0	guide way
SCT2881F	0-200A	0-10V	0.1, 0.2	10/3s	3* Ø 20.0	guide way
SCT2891A	0-400A	0-10V	0.1, 0.2	10/3s	3* Ø 30.0	Screw
SCT2891B	0-400A	0-10V	0.1, 0.2	10/3s	3* Ø 30.0	Screw
SCT2892	0-630A	0-10V	0.1, 0.2	10/3s	3* Ø 35.0	Screw
SCT2893	0-800A	0-10V	0.1, 0.2	10/3s	3* Ø 40.0	Screw

# SCT28 Series

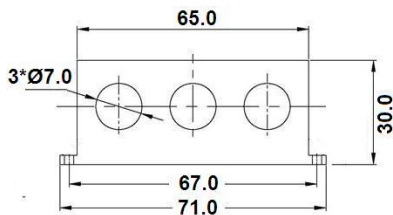

SCT2861

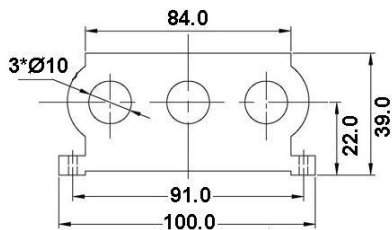

SCT2871

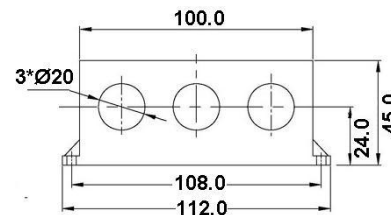

SCT2881A

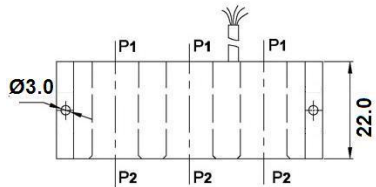

SCT2881B

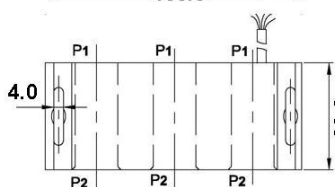

SCT2881D

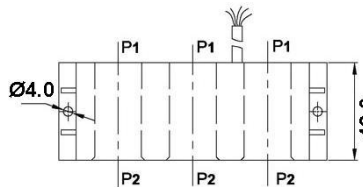

SCT2891A

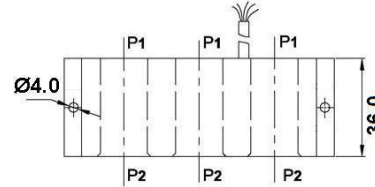
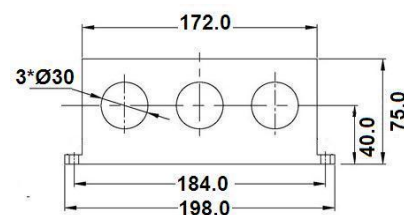
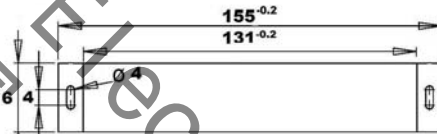
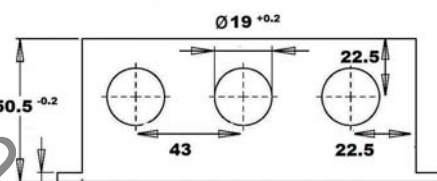
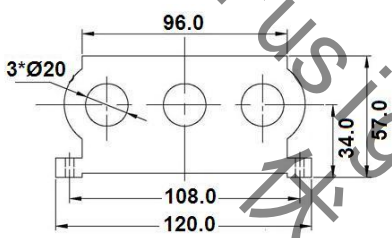

SCT2891A

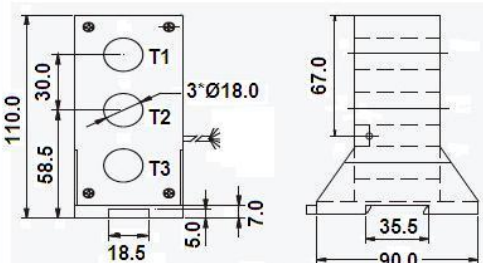

SCT2881E

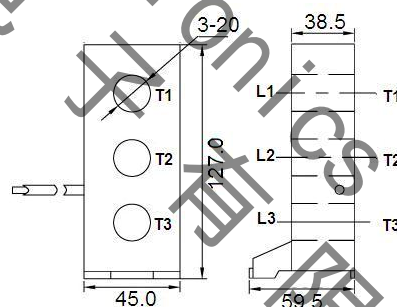

SCT2881F

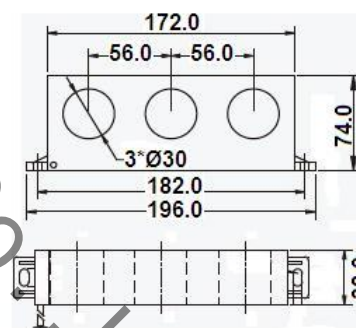

SCT2891B

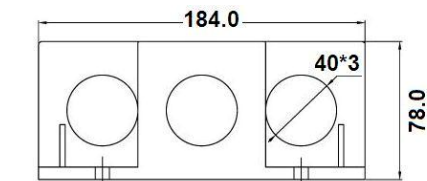

SCT2893

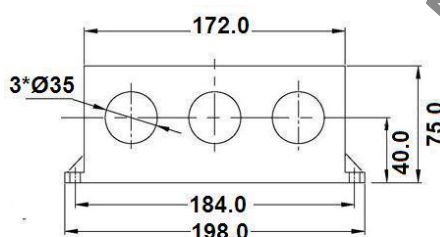

SCT2892

