



伏赛电子有限公司
Fusign Electronics Co., Ltd

型号

EFD-1501

REV	REVISIONS REC	DATE

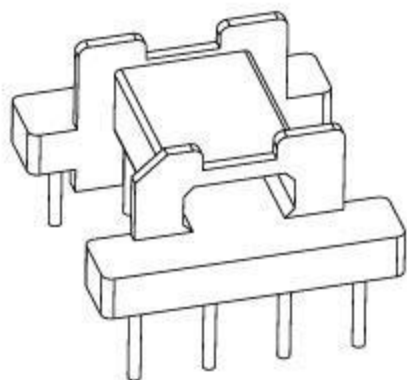
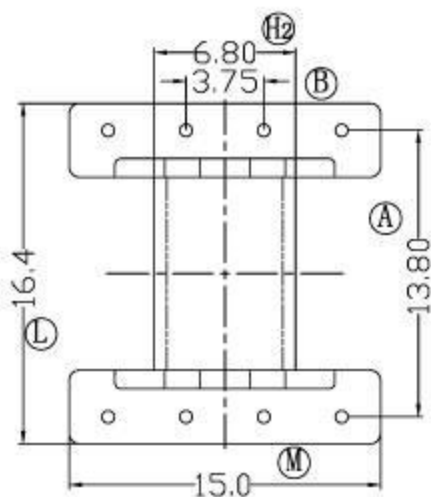
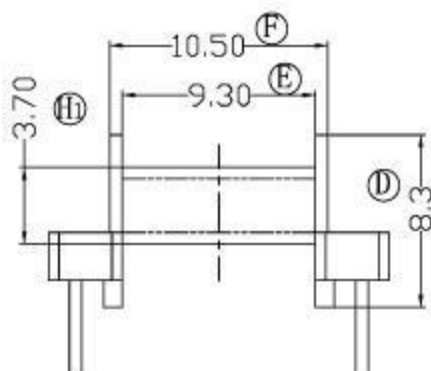
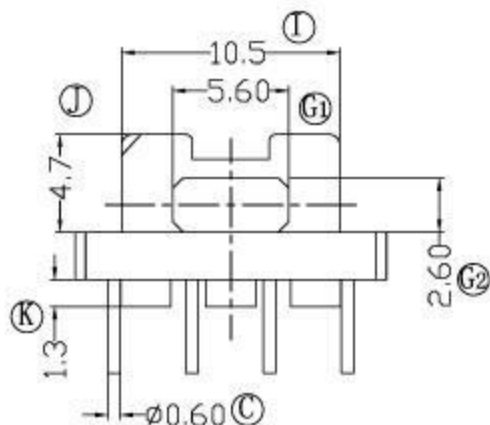

DRAWN BY	JING LI PENG
CHECKER BY	LING RONG WANG
DATE	01-01-2008

TOLERANCE	
X. X	± 0.3
X. XX	± 0.2
壁厚:	± 0.15
PINPITCH	± 0.2

MODEL NAME: EFD15-8P-1S	
BOBBIN MATERIAL: PHENOLIC	
SCALE: 2:1	SCALE: UL 94V-0
	SCALE: M/M