



伏赛电子有限公司
Fusign Electronics Co., Ltd

型号

EEL-1902

REV	REVISIONS REC	DATE

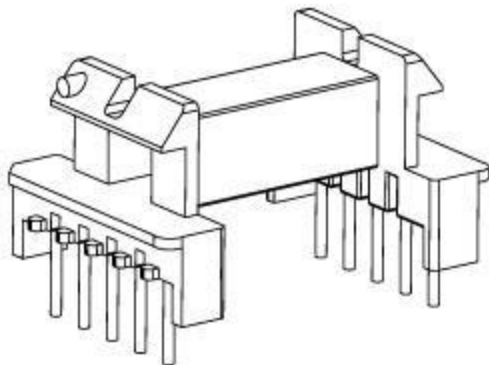
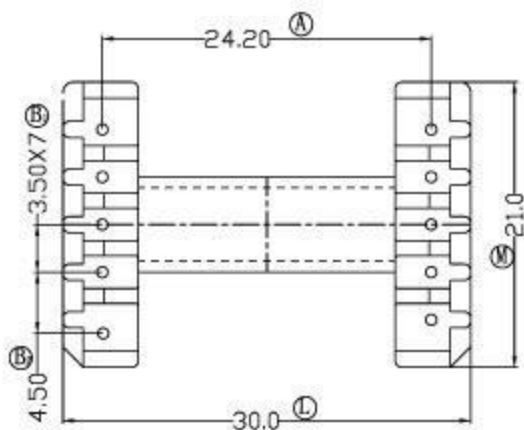
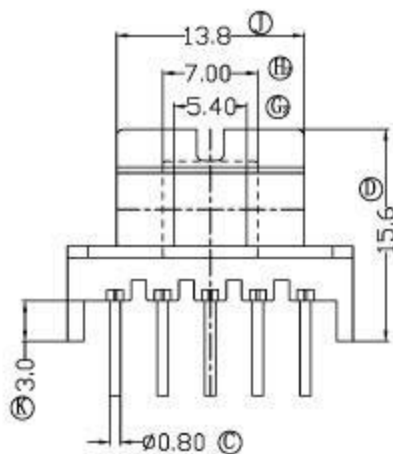
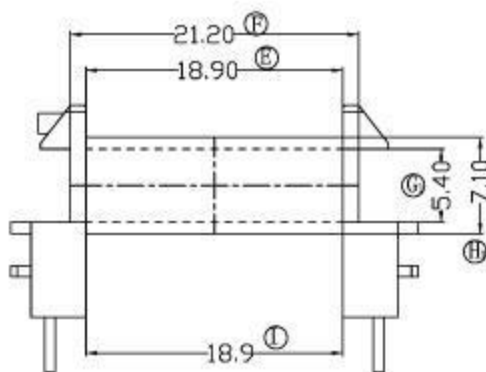

DRAWN BY	JING LI PENG	TOLERANCE	MODEL NAME:	EEL-19 (5+5P)	
CHECKER BY	LING RONG WANG		X. X ± 0.3 X. XX ± 0.2 壁厚: ± 0.15 PINPITCH ± 0.2	BOBBIN MATERIAL:	PHENOLIC
DATE	01-01-2008		SCALE:	2:1	SCALE: UL 94V-0
					SCALE: M/M