



Fusign

伏赛电子有限公司  
Fusign Electronics Co., Ltd

型号

EP-1001

REV	REVISIONS REC	DATE

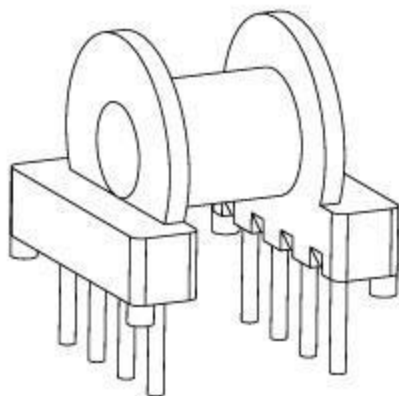
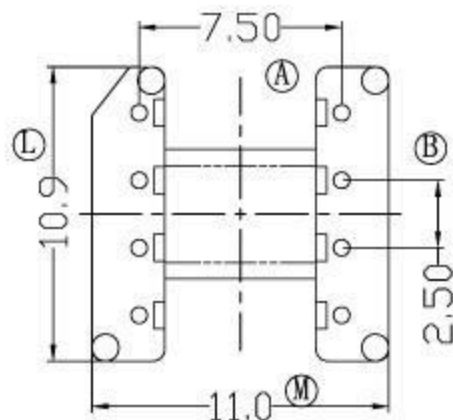
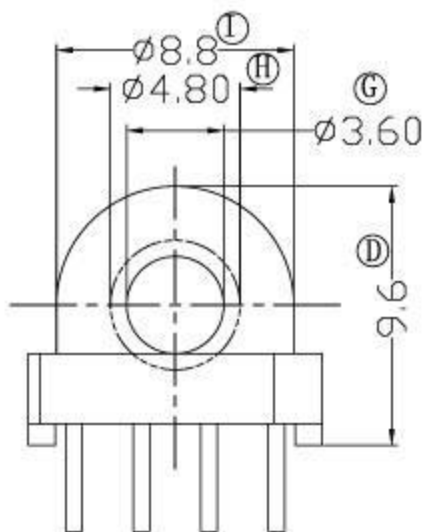
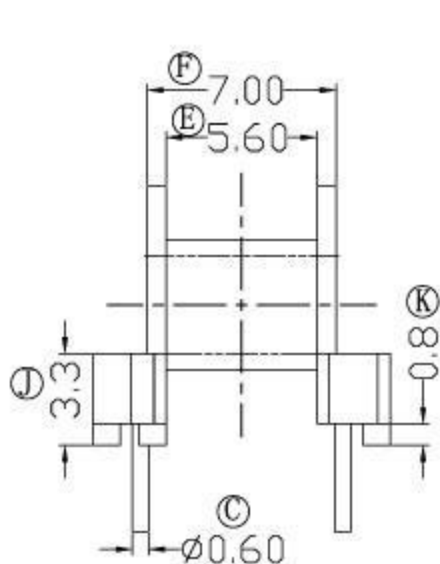

DRAWN BY	JING LI PENG
CHECKER BY	LING RONG WANG
DATE	01-01-2008

TOLERANCE	
X.X	± 0.3
X.XX	± 0.2
壁厚:	± 0.15
PIN PITCH	± 0.2

MODEL NAME: EP10-8P-1S	
BOBBIN MATERIAL: PHENOLIC	
SCALE: 2:1	SCALE: UL 94V-0
	SCALE: M/M