



Fusign

 伏赛电子有限公司  
 Fusign Electronics Co., Ltd

型号

EP-1701

REV	REVISIONS REC	DATE

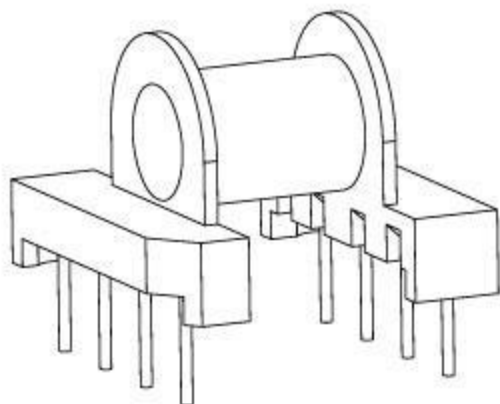
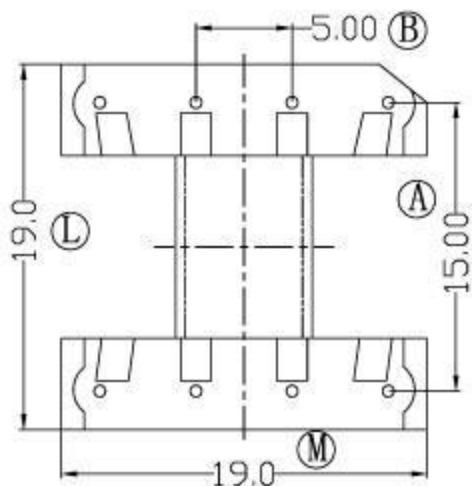
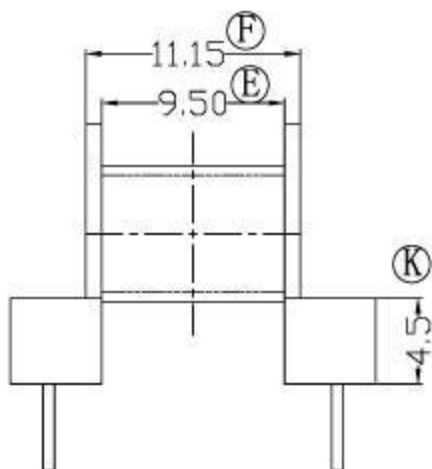
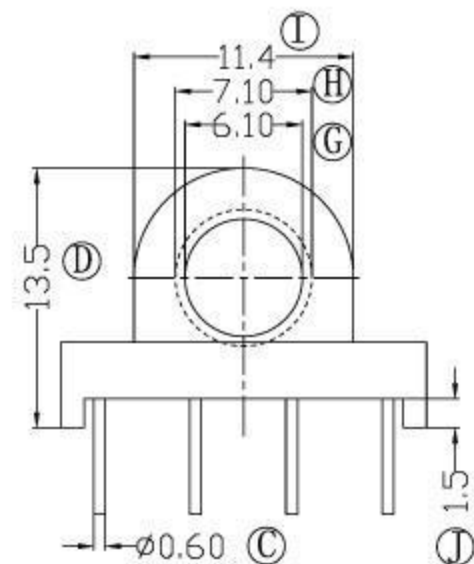

DRAWN BY	JING LI PENG
CHECKER BY	LING RONG WANG
DATE	01-01-2008

TOLERANCE	
X. X	± 0.3
X. XX	± 0.2
壁厚:	± 0.15
PIN PITCH	± 0.2

MODEL NAME:	EP17-8P-1S
BOBBIN MATERIAL:	PHENOLIC
SCALE:	3:1
SCALE:	UL 94V-0
SCALE:	M/M

