



Fusign

伏赛电子有限公司
Fusign Electronics Co., Ltd

型号

ER-3501

REV	REVISIONS REC	DATE

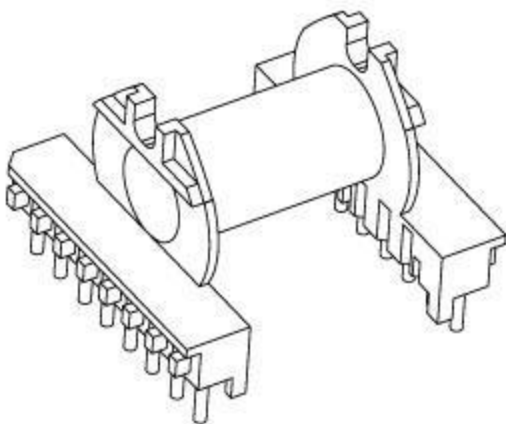
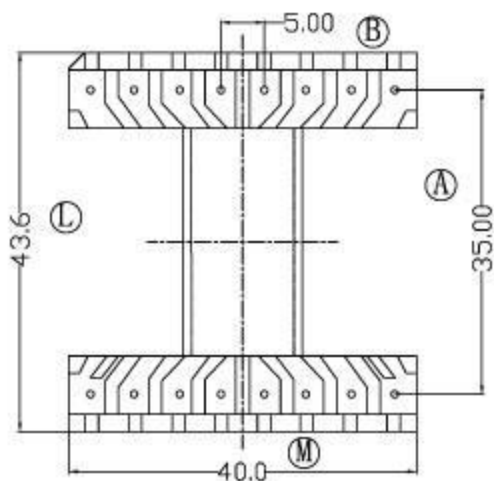
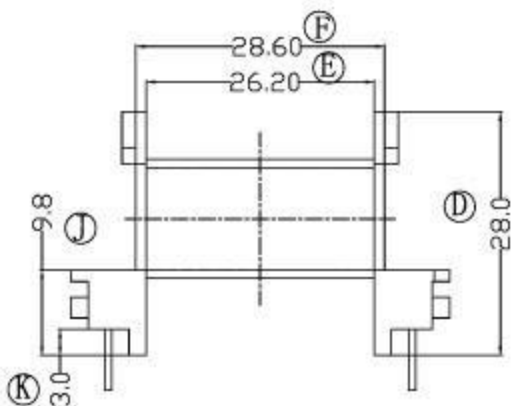
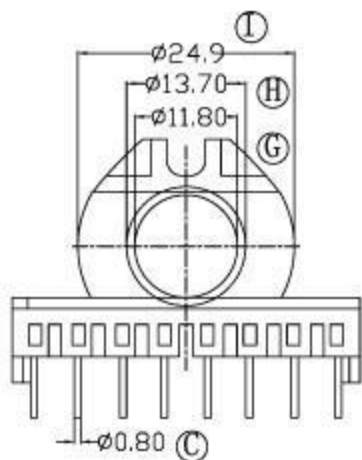

DRAWNBY

JING LI PENG

TOLERANCE

MODEL NAME:

EC-35 (8+8P)

CHECKER BY

LING RONG WANG

X.X ± 0.3
X.XX ± 0.2
壁厚: ± 0.15
PINPITCH ± 0.2

BOBBIN MATERIAL:

PHENOLIC

DATE

01-01-2008

SCALE: 2:1

SCALE: UL 94V-0



SCALE: M/M