



Fusign

伏赛电子有限公司  
Fusign Electronics Co., Ltd

型号

ER-4201

REV	REVISIONS REC	DATE

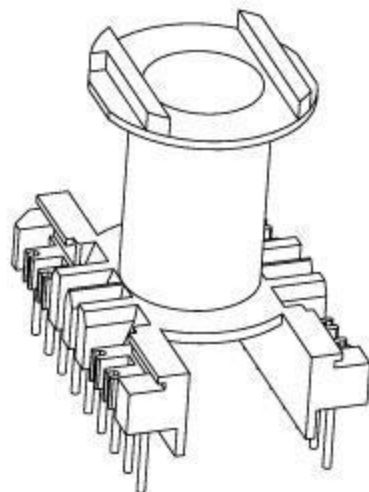
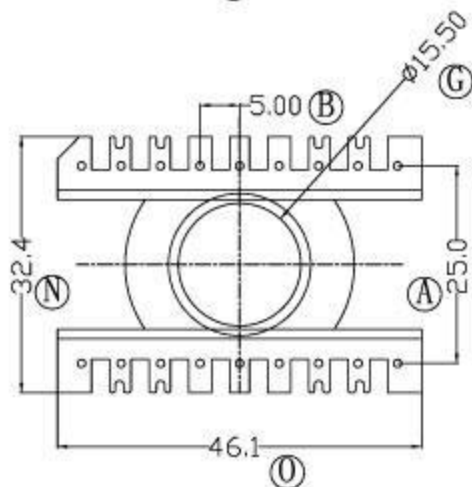
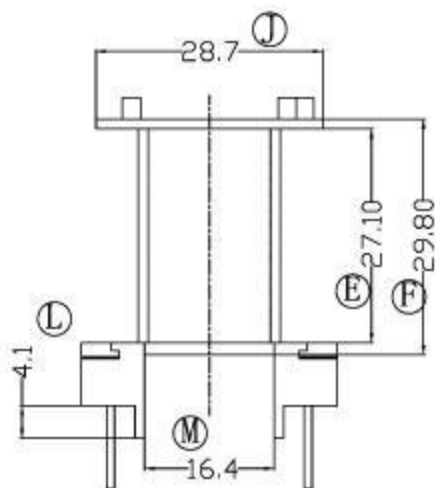
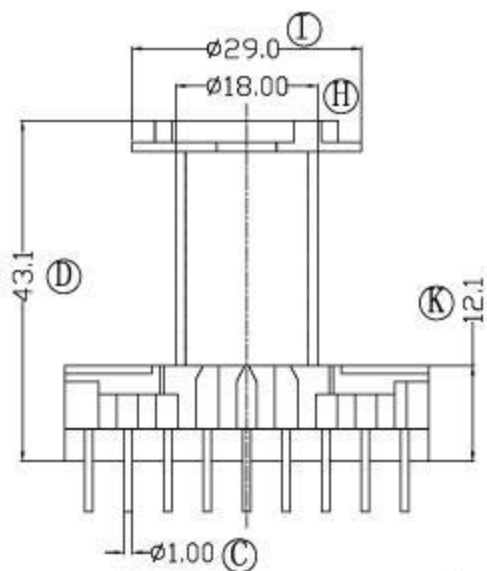

DRAWN BY	JING LI PENG
CHECKER BY	LING RONG WANG
DATE	01-01-2008

TOLERANCE	
X. X	$\pm 0.3$
X. XX	$\pm 0.2$
壁厚:	$\pm 0.15$
PIN PITCH	$\pm 0.2$

MODEL NAME:	EC-42 (9+9P)	
BOBBIN MATERIAL:	PHENOLIC	
SCALE:	2:1	SCALE: UL 94V-0
		SCALE: M/M