



伏赛电子有限公司
Fusign Electronics Co., Ltd

型号

RM-0401

REV	REVISIONS REC	DATE

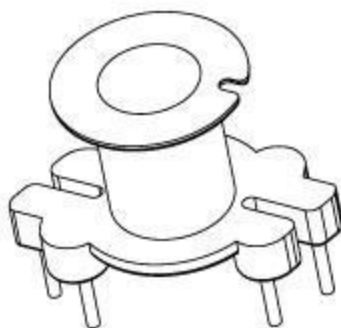
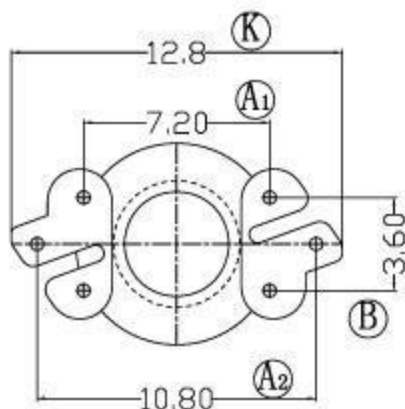
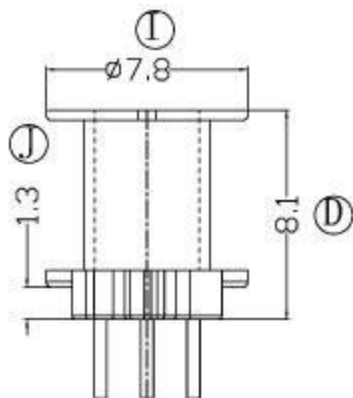
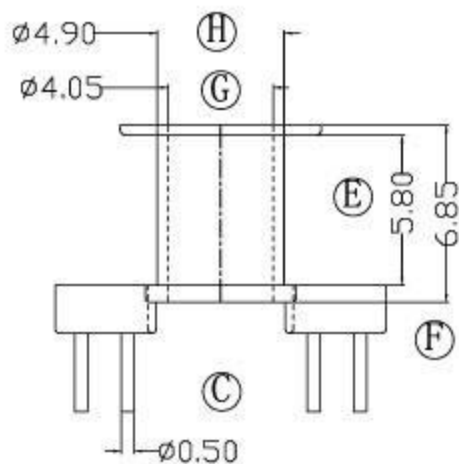

DRAWNBY	JING LI PENG	TOLERANCE	MODEL NAME:	RM4-6P-1S
CHECKER BY	LING RONG WANG	X. X ± 0.3 X. XX ± 0.2 壁厚: ± 0.15 PINPITCH ± 0.2	BOBBIN MATERIAL:	PHENOLIC
DATE	01-01-2008		SCALE: 5:1	SCALE: UL 94V-0
				SCALE: M/M