



伏赛电子有限公司
Fusign Electronics Co., Ltd

型号

RM-0602-1

REV	REVISIONS REC	DATE

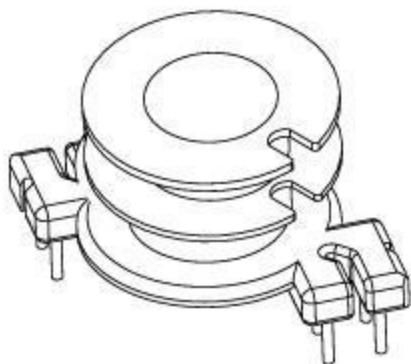
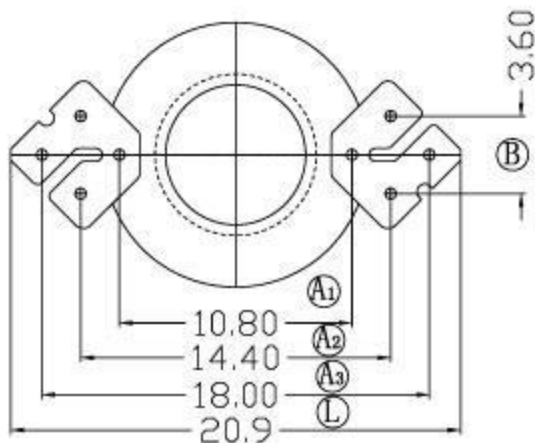
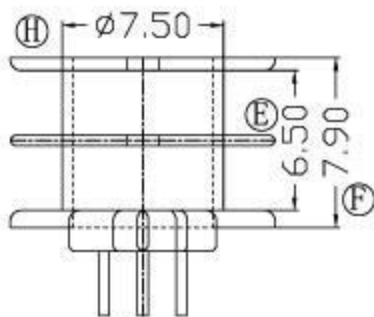
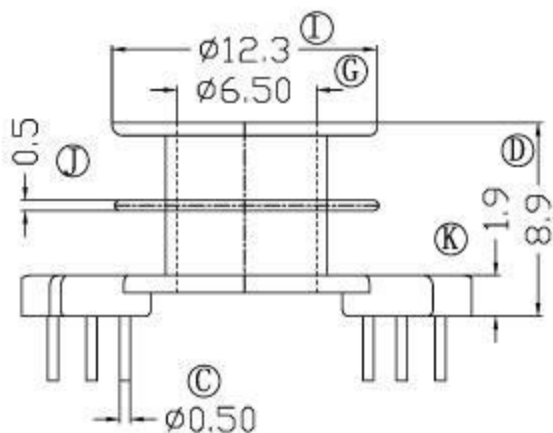

DRAWN BY	JING LI PENG	TOLERANCE	MODEL NAME:	RM6-8P-2S
CHECKER BY	LING RONG WANG		BOBBIN MATERIAL:	PHENOLIC
DATE	01-01-2008	X. X ± 0.3	SCALE: 5:1	SCALE: UL 94V-0
		X. XX ± 0.2		SCALE: M/M
		壁厚: ± 0.15		
		PIN PITCH ± 0.2		